

DUAL OPERATIONAL AMPLIFIER

■ GENERAL DESCRIPTION

The NJM4565 is a high-gain, wide-bandwidth, dual low noise operational amplifier capable of driving 20V peak-to-peak into 400Ω loads. The NJM4565 is good characteristics compared to the NJM4560.

■ FEATURES

- Operating Voltage (±4V~±18V)
- Wide Gain Bandwidth Product (4MHz typ.)
- Slew Rate (4V/μs typ.)
- Package Outline DIP8, DMP8, EMP8, SSOP8, SIP8
- Bipolar Technology

■ PACKAGE OUTLINE

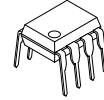

NJM4565D



NJM4565M



NJM4565E



NJM4565V

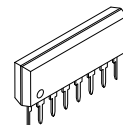

NJM4565L

■ PIN CONFIGURATION

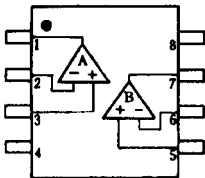

NJM4565D
NJM4565M
NJM4565E
NJM4565V

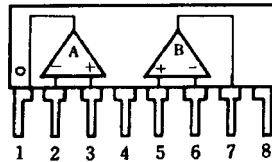

NJM4565L

- PIN FUNCTION**
- 1.A OUTPUT
 - 2.A -INPUT
 - 3.A +INPUT
 - 4.V⁻
 - 5.B +INPUT
 - 6.B -INPUT
 - 7.B OUTPUT
 - 8.V⁺

■ EQUIVALENT CIRCUIT (1/2 Shown)

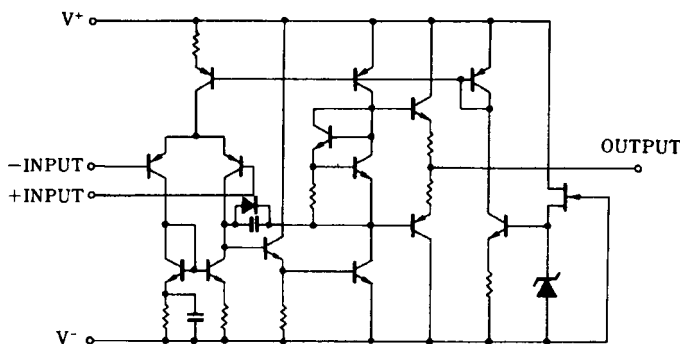

NJM4565

■ ABSOLUTE MAXIMUM RATINGS

(Ta=25°C)

| PARAMETER | SYMBOL | RATINGS | UNIT |
|-----------------------------|-------------|---|------|
| Supply Voltage | V^+ / V^- | ± 18 | V |
| Differential Input Voltage | V_{ID} | ± 30 | V |
| Input Voltage | V_{IC} | ± 15 (note) | V |
| Power Dissipation | P_D | (DIP8) 500 (DMP8) 300 (EMP8) 300 (SSOP8) 250 (SIP8) 800 | mW |
| Operating Temperature Range | T_{opr} | -40~+85 | °C |
| Storage Temperature Range | T_{stg} | -40~+125 | °C |

(note) For supply voltage less than ±15V, the absolute maximum input voltage is equal to the supply voltage.

■ ELECTRICAL CHARACTERISTICS

(Ta=25°C, $V^+ / V^- = \pm 15V$)

| PARAMETER | SYMBOL | TEST CONDITION | MIN. | TYP. | MAX. | UNIT |
|---------------------------------|-----------|-------------------------------------|------|--------|------|-------|
| Input Offset Voltage | V_{IO} | $R_S \leq 10k\Omega$ | - | 0.5 | 3.0 | mV |
| Input Offset Current | I_{IO} | | - | 2 | 50 | nA |
| Input Bias Current | I_B | | - | 50 | 200 | nA |
| Input Resistance | R_{IN} | | 0.3 | 5 | - | MΩ |
| Large Signal Voltage Gain | A_V | $R_L \geq 2k\Omega, V_O = \pm 10V$ | 86 | 100 | - | dB |
| Maximum Output Voltage Swing 1 | V_{OM1} | $R_L \geq 2k\Omega$ | ± 12 | ± 14 | - | V |
| Maximum Output Voltage Swing 2 | V_{OM2} | $I_O = 25mA$ | ± 10 | ± 11.5 | - | V |
| Input Common Mode Voltage Range | V_{ICM} | | ± 12 | ± 14 | - | V |
| Common Mode Rejection Ratio | CMR | $R_S \leq 10k\Omega$ | 70 | 90 | - | dB |
| Supply Voltage Rejection Ratio | SVR | $R_S \leq 10k\Omega$ | 76.5 | 90 | - | dB |
| Operating Current | I_{CC} | | - | 4.5 | 7 | mA |
| Slew Rate | SR | | - | 4 | - | V/μs |
| Gain Bandwidth Product | GB | | - | 10 | - | MHz |
| Equivalent Input Noise Voltage | V_{NI} | RIAA, $R_S = 2.2k\Omega, 30kHz$ LPF | - | 1.2 | - | μVrms |

■ TYPICAL CHARACTERISTICS

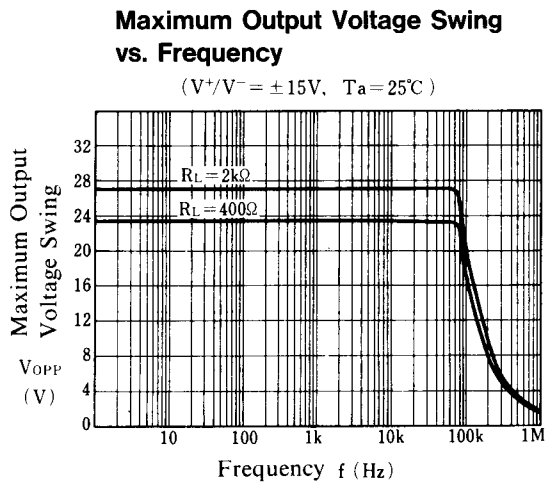

Equivalent Input Noise Voltage vs. Frequency

($V^+/V^- = \pm 15V$, $R_s = 1k\Omega$, $T_a = 25^\circ C$)

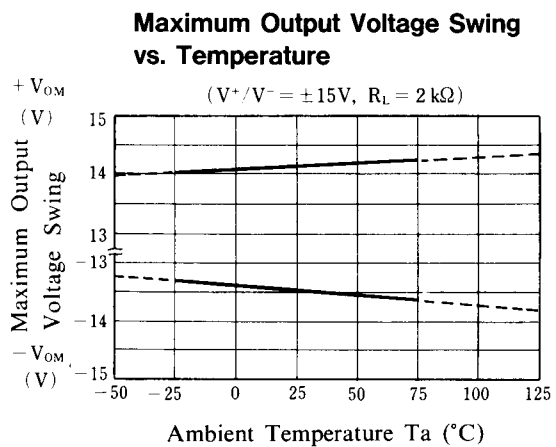
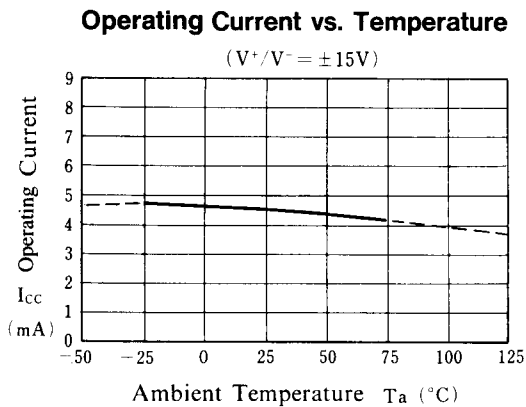
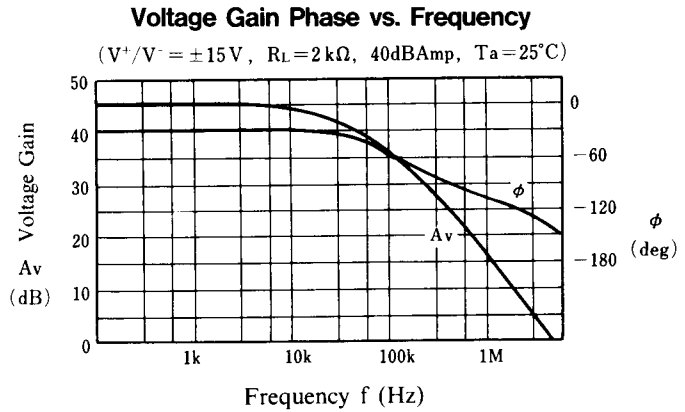
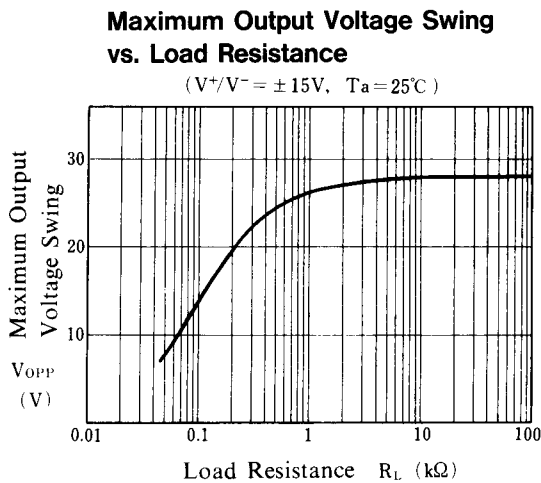
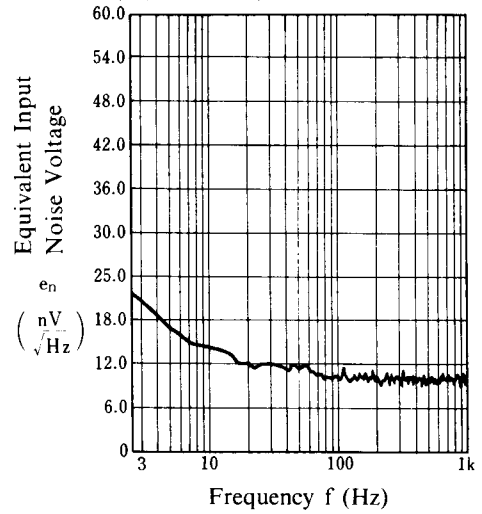

■ TYPICAL CHARACTERISTICS

Input Offset Voltage vs. Temperature

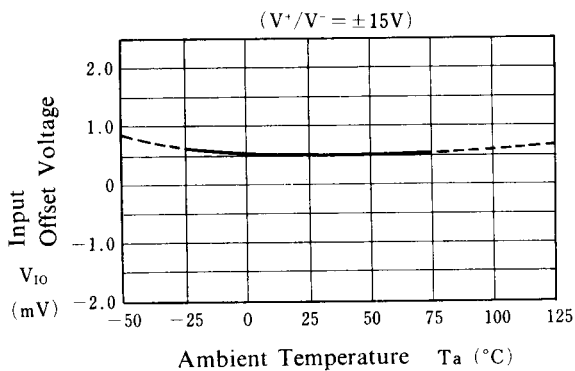

Input Bias Current vs. Temperature

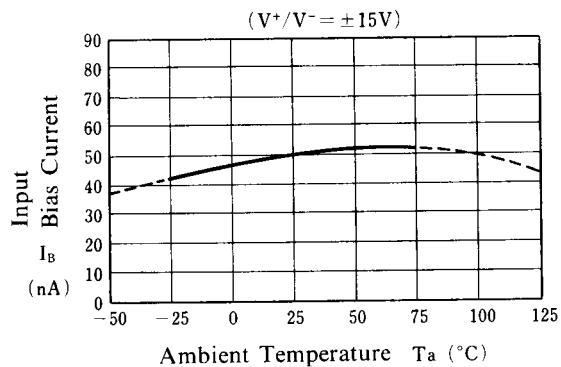

Maximum Output Voltage Swing vs. Operating Voltage

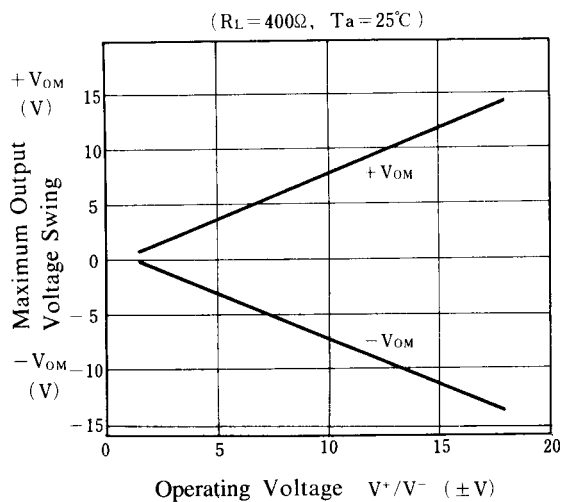

Operating Current vs. Operating Voltage

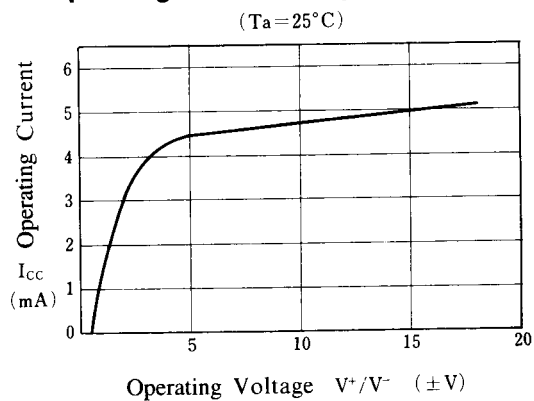

[CAUTION]

The specifications on this databook are only given for information, without any guarantee as regards either mistakes or omissions. The application circuits in this databook are described only to show representative usages of the product and not intended for the guarantee or permission of any right including the industrial rights.